

Activity book

Key Stage 2

LFB
LONDON FIRE BRIGADE

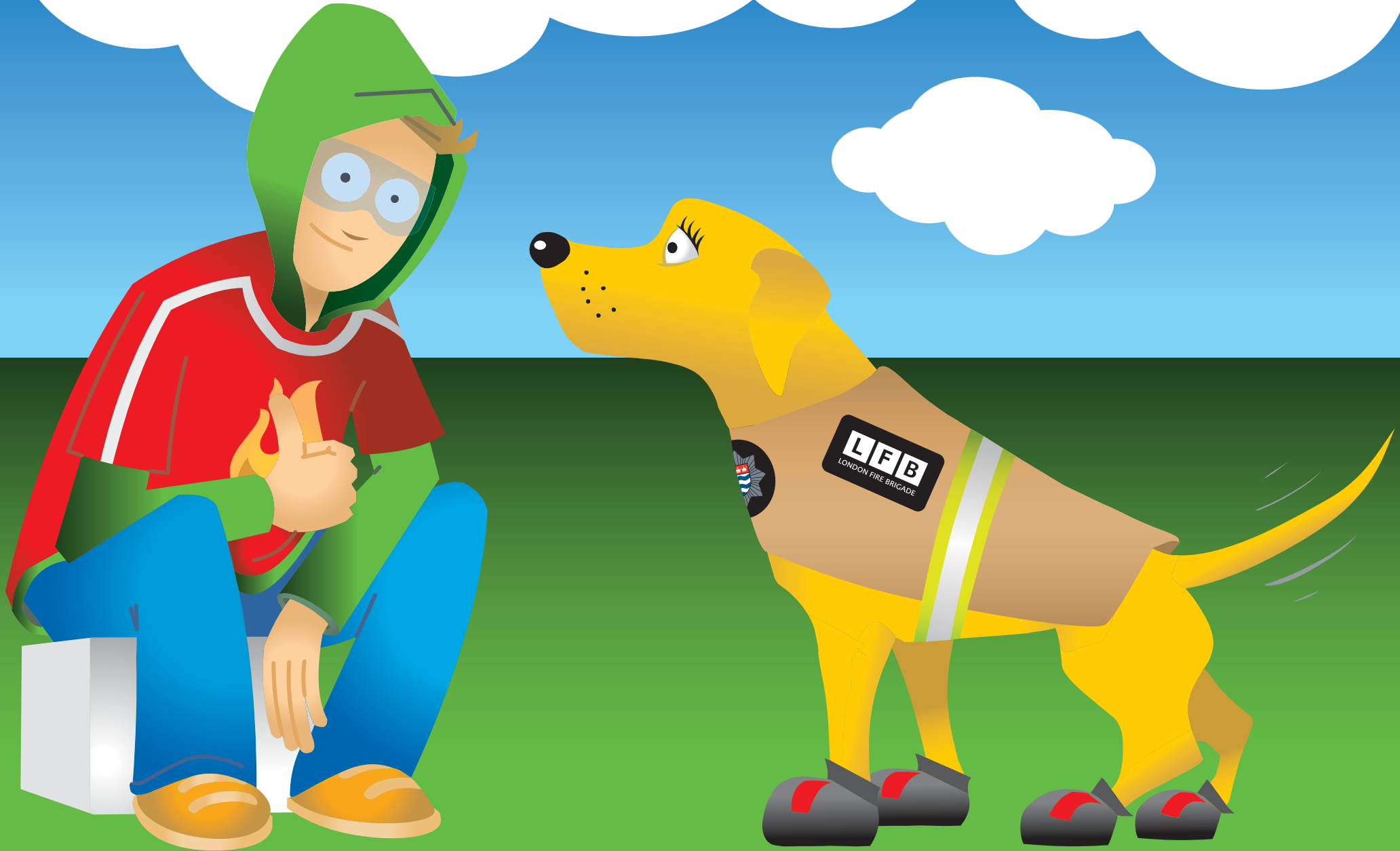

Hi people!

My name is Flynn, I'm a teenager, and in my spare time I help London Fire Brigade talk to young people so they understand the dangers of fire. Before you ask why I don't spend my spare time on the computer or playing footy like most kids my age, let me explain a bit more about myself....

If you're anything like I used to be, you probably don't think about fire too much, because it isn't something you really have to deal with in real life. I mean, you see it on the TV, but the people always seem to get out of it without getting hurt. So why worry about it? That was my attitude until ...

On a normal day like any other, there was a real fire on the news, and it was round my way! I even knew the family that lived there. Someone had left the cooker on overnight by accident, so when the fire started everyone was asleep. Luckily they had smoke alarms though, which woke them up, and they managed to escape. It was really close though! That was when

I realised that fire was something that does happen in real life, and I didn't want it happening to me or anyone I care about. So I got in touch with my local fire station to find out more.

Ever since then I have been helping young people understand what can be done to make sure fire doesn't affect you or your family. I helped put together this Activity Book especially to improve your understanding of fire safety. I've done my best to make the activities tricky but fun, so I hope you enjoy the challenge of doing them. There are a few games in here that I think your adults at home would find hard, so why not set them a challenge too? I bet you can beat them hands down ...

Look after your book, because you never know – what you learn from it could one day come in very useful. Good luck!

Flynn



Contents



- 1** Adey's crossword
- 2** Flynn's word search
- 3** Adey's fire safety code buster
- 4** Flynn's escape maze
- 5** Make your own Noisy
- 7** Bernie Bear's origami firefighter's helmet
- 9** Bernie Bear's spot the difference
- 11** Flynn's hazard house game

Adey's crossword

Figure out the clues, and write your answers next to the number in the crossword.

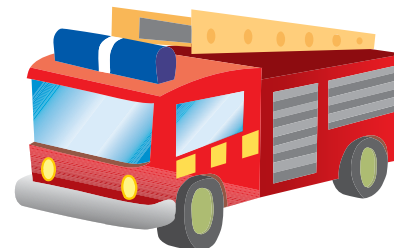
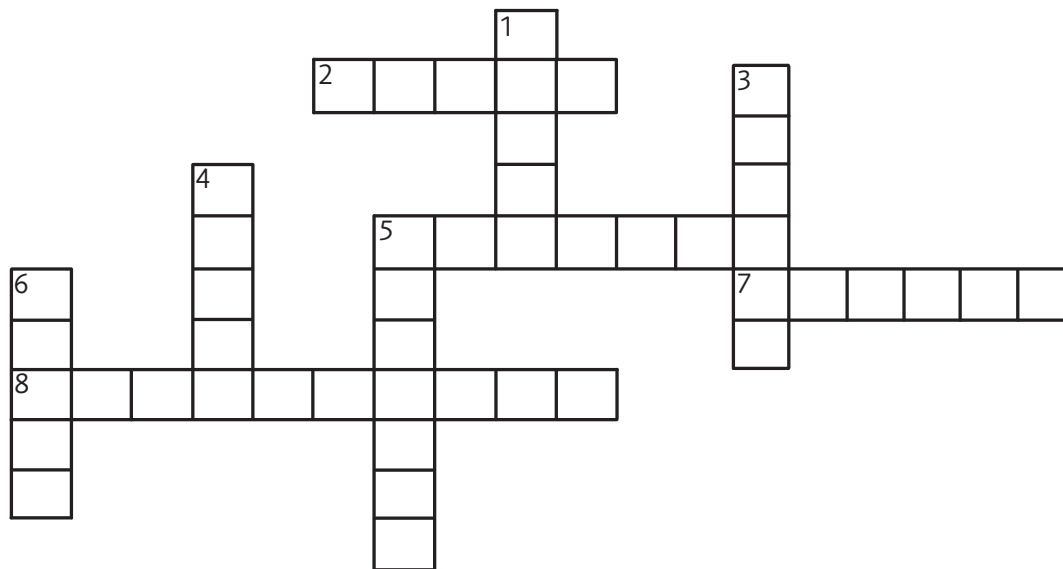

ACROSS

2. Make sure the way in and out of your home is kept _____. (5)
5. Test your alarms every month, it's as simple as _____ the button. (7)
7. Take a few minutes to practice your _____ route regularly. (6)
8. Firefighters can see each other in the dark as they have _____ strips on their jackets. (10)

DOWN

1. Firefighters wear them to be able to breath when there is smoke. (5)
3. Fire will go out if there is no more heat, fuel or _____. (6)
4. We should _____ on the floor to avoid smoke when escaping from a fire. (5)
5. Firefighters wear a uniform to _____ themselves from fire. (7)
6. It makes a long and loud warning sound on fire engines. (5)

Flynn's word search

Look carefully to find the listed words hidden in the word search grid. Don't give up – keep going until you find them all!



smoke
fire
cooking
candles
lighters
matches
electricity
sockets
unplug
fireworks
crawl
unattended
charger
escape
plan
mobile
telephone
safety
steam

T	W	U	J	C	P	Q	O	W	U	N	Y	Y	H	I
U	R	Y	O	N	H	E	L	I	G	H	T	E	R	S
P	N	C	N	X	D	A	P	U	P	R	I	S	S	E
I	Q	A	R	I	F	E	R	B	W	H	C	C	T	H
M	T	N	T	L	I	E	N	G	M	T	I	A	E	C
D	Y	D	A	T	R	S	U	O	E	R	R	P	A	T
Y	J	L	G	Z	E	O	J	Q	H	R	T	E	M	A
Z	X	E	S	L	W	N	Q	Z	E	P	C	J	D	M
G	S	S	A	G	O	G	D	W	M	I	E	J	I	I
U	O	P	F	F	R	N	L	E	A	X	L	L	W	A
L	C	L	E	I	K	I	K	Z	D	Q	E	V	E	V
P	K	A	T	R	S	K	T	W	W	L	D	N	J	T
N	E	N	Y	E	I	O	I	V	T	T	R	C	I	X
U	T	E	L	I	B	O	M	Y	B	Z	A	Q	F	V
U	S	L	W	A	R	C	E	U	S	M	O	K	E	R

Adey's fire safety code buster

Adey wants to explain something to you that is really important to know. But first you have to use the code at the top of the worksheet to figure out what that is!

Match each number in Adey's message to the letter in the code bar. Once you have read the message, pass it on to your families at home.

0	1	2	3	4	5	6	7	8	9	10	11	12	13	14	15	16	17	18	19	20	21	22	23	24	25
L	T	K	N	Z	O	Q	E	Y	U	M	H	S	D	F	A	W	P	J	G	V	I	C	R	B	X

2	7	7	17	8	5	9	23	14	15	10	21	0	8
12	15	14	7	14	23	5	10	11	15	23	10		
19	7	1	12	10	5	2	7	15	0	15	23	10	12

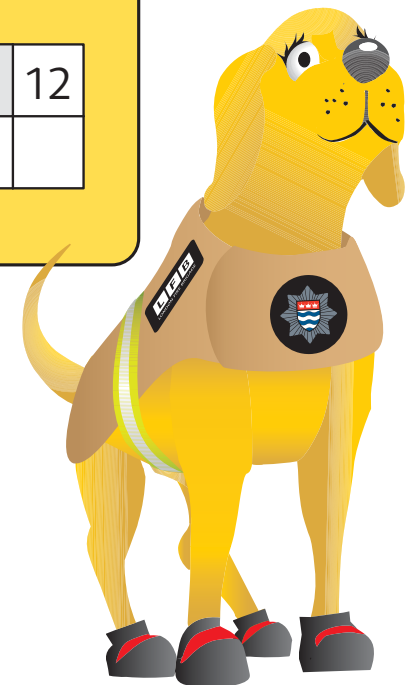
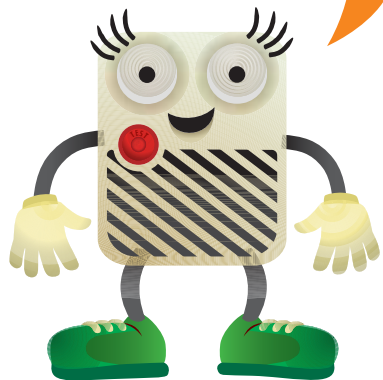

Flynn's escape maze

Uh-oh, the house is on fire,
and you are stuck inside!

From the starting point shown,
carefully draw TWO safe ways
out of the house. When you
are done, check your work.
Are you sure you have
picked the SAFE ways out??



Make your own Noisy

Follow these instructions to make a cut-out of me.

You will need:

- glue stick
- felt tip pens
- scissors

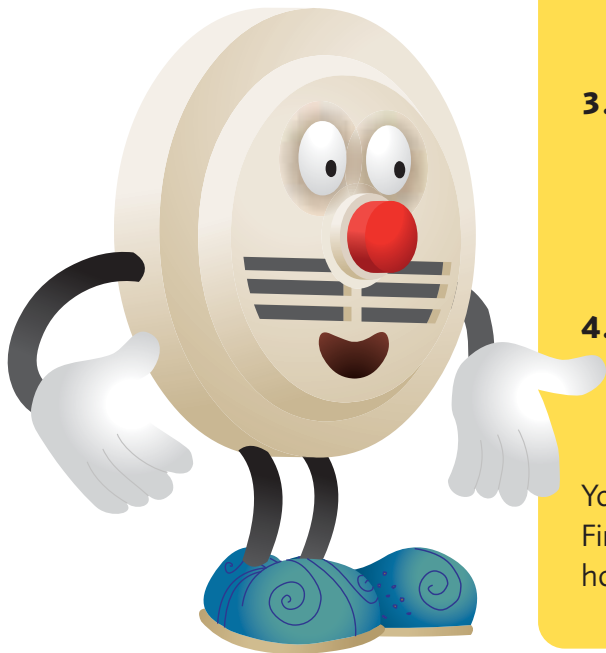

1. Colour in Noisy's:

- eyes
- mouth
- nose
- hands
- boots

2. Write one of these fire safety messages on Noisy's sign, and then colour it in:

- Working smoke alarms save lives!
- Test us every month
- Every home should have smoke alarms

3. Carefully cut out all of Noisy's parts and stick them together to create your own Noisy. You may need to ask a grown-up to help you with this.

4. Put your Noisy on a wall where everyone can see it!

Your Noisy will help London Fire Brigade make sure every home has a working smoke alarm.

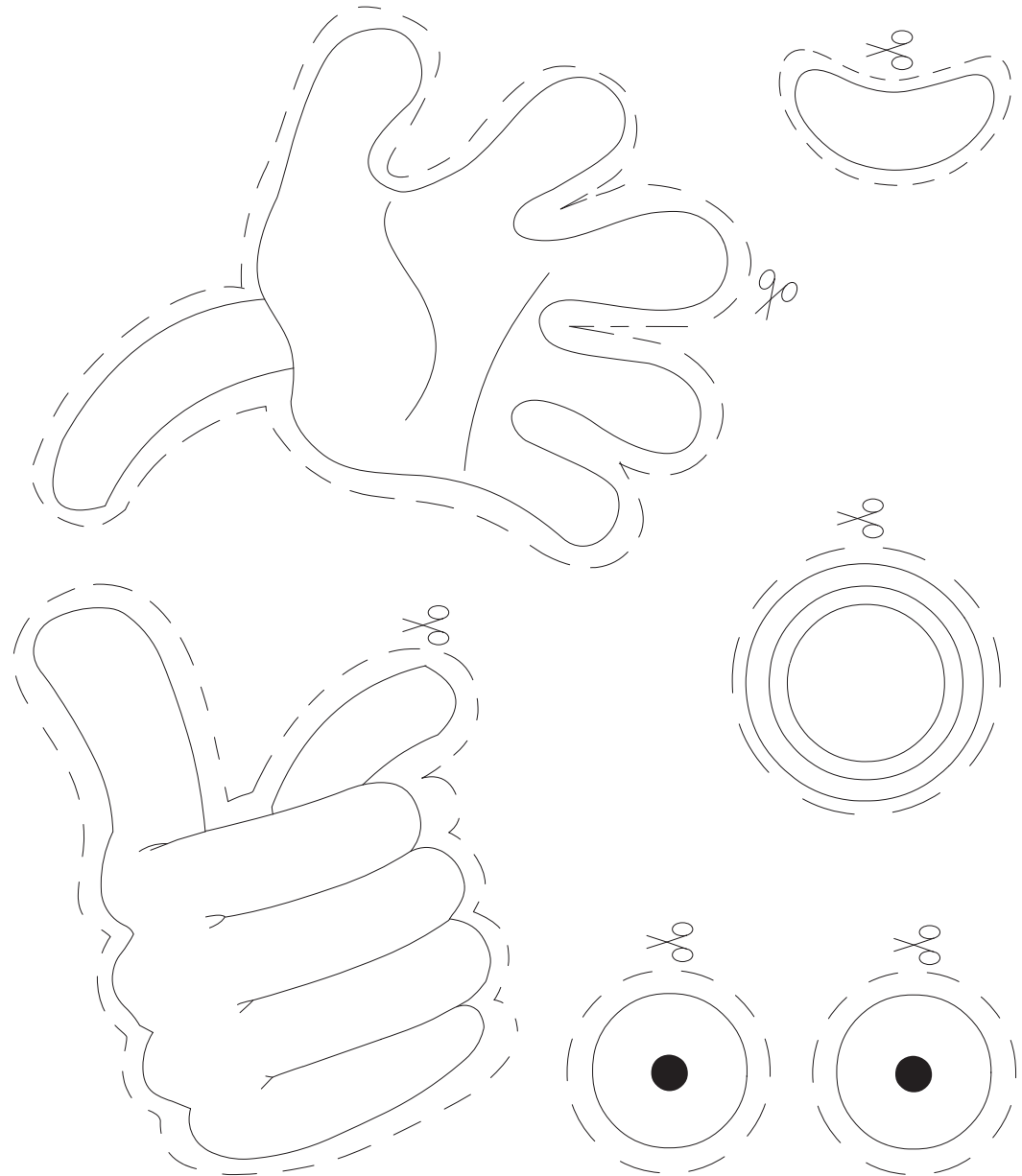

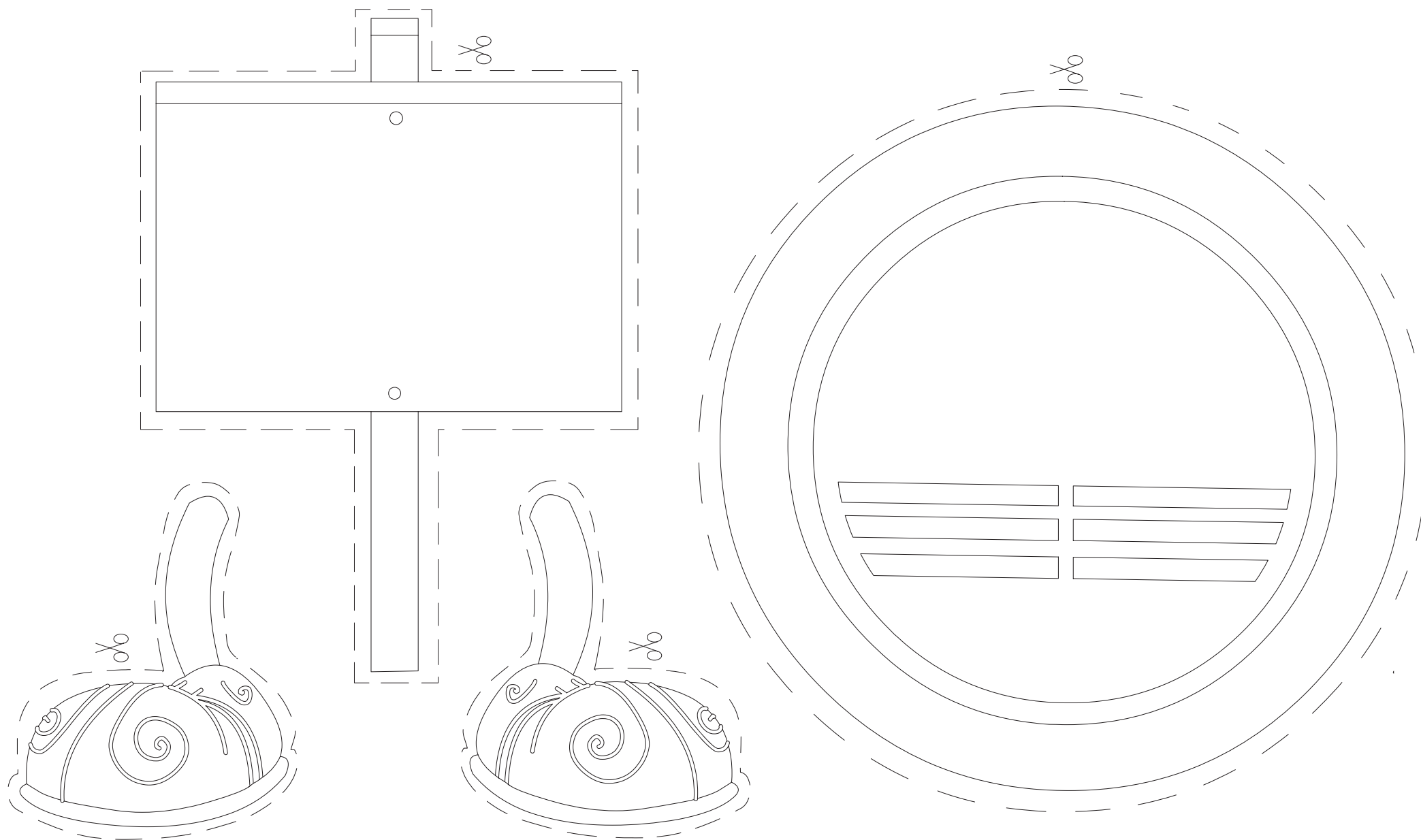

Bernie Bear's origami firefighter's helmet

Follow the instructions to fold a firefighter's helmet out of a single piece of paper.

Challenge your adults at home to try it – I bet you do better than they do!

You will need:

- Glue stick
- A3 paper
- felt tip pens

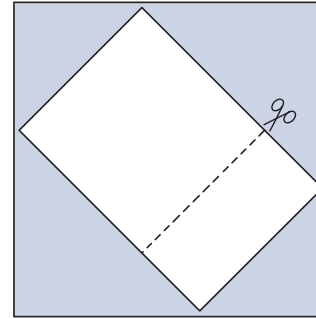

1. Take a sheet of paper and cut a strip off to make a square as shown.

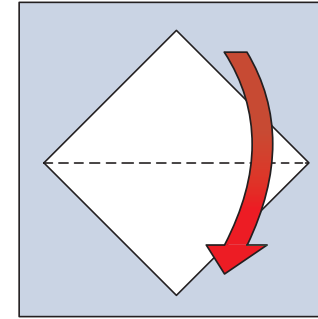

2. Fold the square in half along the dotted line.

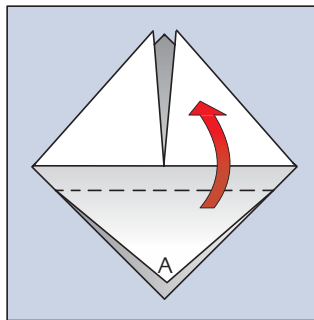
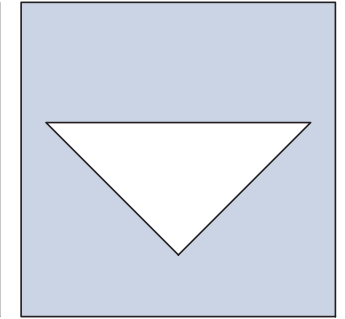

6. Fold the top flap A along the dotted line.

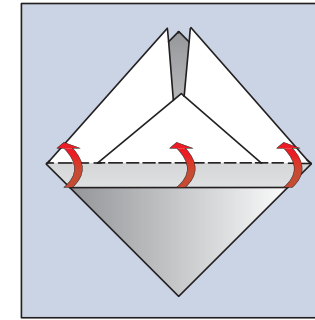
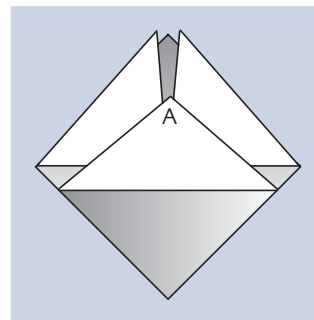

7. Make a crease along the dashed line then fold as shown.

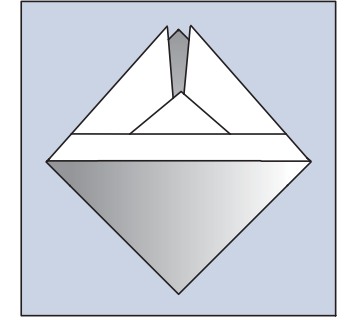

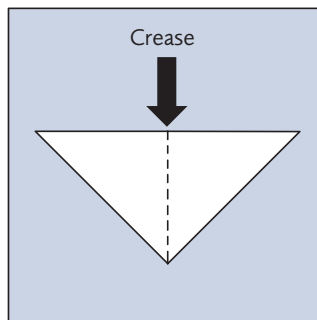
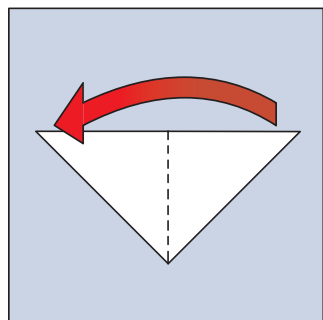

3. Fold along the dotted line to make a crease as shown. Then fold back again.

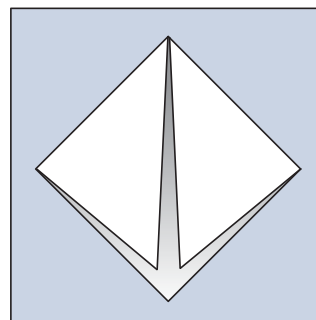
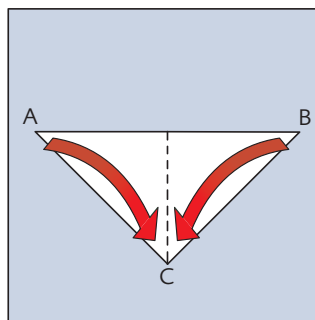

4. Fold corner A towards corner C and then fold corner B towards corner C.

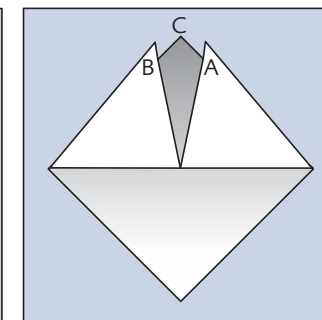
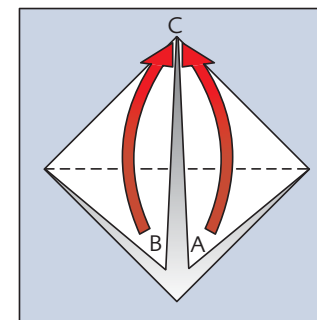

5. Fold corner A to meet corner C and then fold corner B to meet corner C.

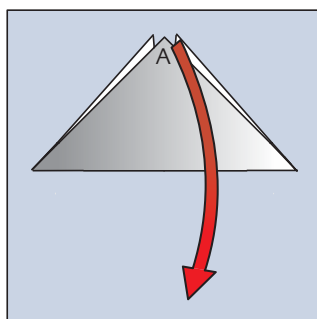
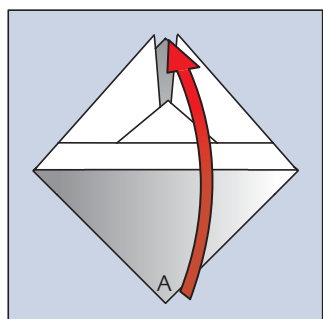

8. Fold corner A as shown and fold back again.

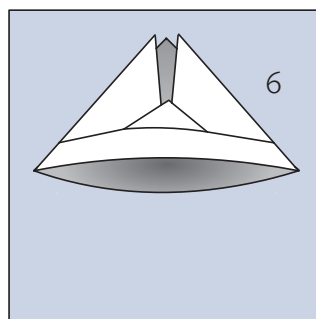
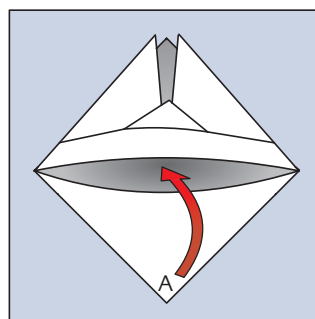

9. Tuck corner A inside the helmet as shown.

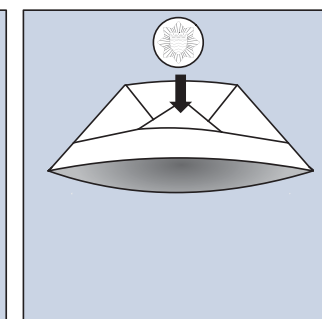
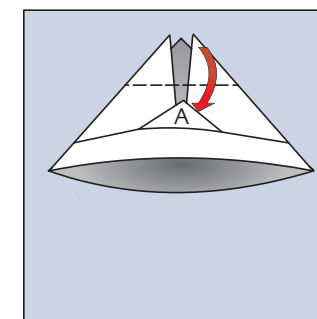

10. Fold the pointed top of the helmet over and tuck it under triangular flap A as shown.



11. Stick on the LFB Badge (left) and colour your helmet in!

Bernie Bear's spot the difference

Here is a photo to try our spot the difference. Look very carefully and see if you can spot them all.



There are 15 differences to spot between these two pictures. Good luck!



Flynn's hazard house game

Look carefully at this picture of the lounge. There are heaps of dangers in here that could easily start a fire.

Draw a circle around anything that you think is not safe. There are 15 fire hazards to spot.

Once you are done, talk to your family about any fire dangers you think there might be in your own home.



Bye people! We hope you had fun.

Send London Fire Brigade a postcard or a letter, to tell us what you enjoyed doing most in your activity book, and what you learned. You can even draw us a picture if you like! Send them to this address:

Education Team
3rd Floor
London Fire Brigade Headquarters
169 Union St
London SE1 0LL

london-fire.gov.uk/schools/primary-school-visits/

Did you know ...

You can book a free home fire safety visit

Freephone: 0800 028 4428

Email: smokealarms@london-fire.gov.uk

Text/SMS: 07860 021 319



